

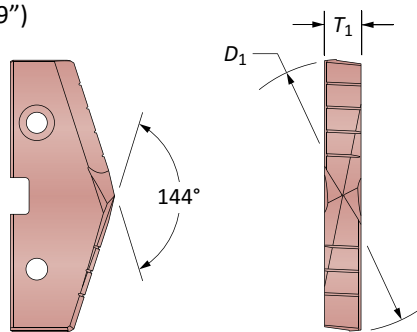

**GEN2 T-A® Drill Inserts**

8 Series | HSS | Diameter Range: 101.63mm - 160.00mm (4.001" - 6.299")

(for use with 7 series holders)



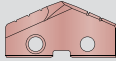

**HSS Inserts – Super Cobalt | HSS**

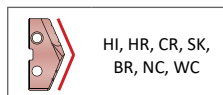
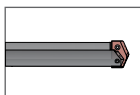
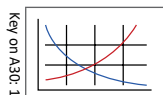
Insert				Super Cobalt Part No.	HSS Part No.
$D_1$ mm	$D_1$ inch	Fractional Equivalent	$T_1$ mm	 AM200®	
102.00	4.0157	4-1/64	11.11	<b>458H-102</b>	
103.19	4.0625	4-1/16		<b>458H-0402</b>	
104.00	4.0945	4-3/32		<b>458H-104</b>	
104.75	4.1250	4-1/8		<b>458H-0404</b>	
106.00	4.1732	-		<b>458H-106</b>	
106.36	4.1875	4-3/16		<b>458H-0406</b>	
107.95	4.2500	4-1/4		<b>458H-0408</b>	
108.00	4.2520	-		<b>458H-108</b>	
109.54	4.3125	4-5/16		<b>458H-0410</b>	
110.00	4.3307	-		<b>458H-110</b>	
111.13	4.3750	4-3/8		<b>458H-0412</b>	
112.00	4.4094	-		<b>458H-112</b>	
112.71	4.4375	4-7/16		<b>458H-0414</b>	
114.00	4.4882	-		<b>458H-114</b>	
114.30	4.5000	4-1/2		<b>458H-0416</b>	



Coatings not listed above can be supplied as non-stocked standards.



Inserts sold in quantities of 1	
	
	<b>AM200® = 131H-XXXX</b>