

### T-A® Original Drill Inserts

0 Series | HSS | Diameter Range: 12.98mm - 17.65mm (0.511" - 0.695")

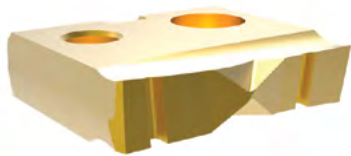

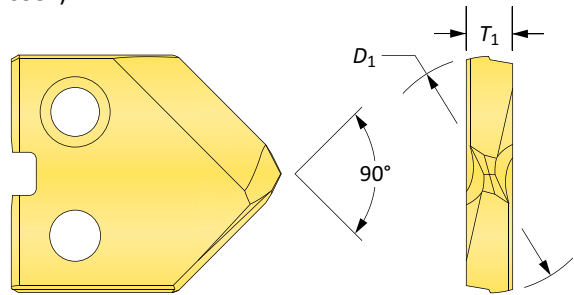



90° Spot & Chamfer

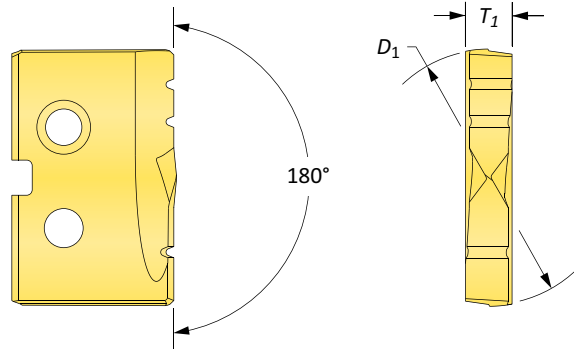



Flat Bottom



HSS Inserts – Super Cobalt

Series	Insert				90° Spot & Chamfer Part No.			Flat Bottom Part No.
	D <sub>1</sub> mm	D <sub>1</sub> inch	Fractional Equivalent	T <sub>1</sub> mm	 TiN	 TiAlN	 TiCN	 TiN
0	13.00	0.5118	–	3.18	150T-13-SP	150A-13-SP	150N-13-SP	150T-13-FB
	13.10	0.5156	33/64		150T-.515-SP	150A-.515-SP	150N-.515-SP	150T-.515-FB
	13.49	0.5313	17/32		150T-0017-SP	150A-0017-SP	150N-0017-SP	150T-0017-FB
	13.50	0.5315	–		150T-13.5-SP	150A-13.5-SP	150N-13.5-SP	150T-13.5-FB
	13.89	0.5469	35/64		150T-.546-SP	150A-.546-SP	150N-.546-SP	150T-.546-FB
	14.00	0.5512	–		150T-14-SP	150A-14-SP	150N-14-SP	150T-14-FB
	14.29	0.5625	9/16		150T-0018-SP	150A-0018-SP	150N-0018-SP	150T-0018-FB
	14.50	0.5709	–		150T-14.5-SP	150A-14.5-SP	150N-14.5-SP	150T-14.5-FB
	14.68	0.5781	37/64		150T-.578-SP	150A-.578-SP	150N-.578-SP	150T-.578-FB
	15.00	0.5906	–		150T-15-SP	150A-15-SP	150N-15-SP	150T-15-FB
0.5	15.08	0.5938	19/32	3.18	150T-0019-SP	150A-0019-SP	150N-0019-SP	150T-0019-FB
	15.48	0.6094	39/64		150T-.609-SP	150A-.609-SP	150N-.609-SP	150T-.609-FB
	15.50	0.6102	–		150T-15.5-SP	150A-15.5-SP	150N-15.5-SP	150T-15.5-FB
	15.88	0.6250	5/8		150T-0020-SP	150A-0020-SP	150N-0020-SP	150T-0020-FB
	16.00	0.6299	–		150T-16-SP	150A-16-SP	150N-16-SP	150T-16-FB
	16.27	0.6406	41/64		150T-.640-SP	150A-.640-SP	150N-.640-SP	150T-.640-FB
	16.50	0.6496	–		150T-16.5-SP	150A-16.5-SP	150N-16.5-SP	150T-16.5-FB
	16.67	0.6563	21/32		150T-0021-SP	150A-0021-SP	150N-0021-SP	150T-0021-FB
	17.00	0.6693	–		150T-17-SP	150A-17-SP	150N-17-SP	150T-17-FB
	17.07	0.6719	43/64		150T-.671-SP	150A-.671-SP	150N-.671-SP	150T-.671-FB
	17.46	0.6875	11/16		150T-0022-SP	150A-0022-SP	150N-0022-SP	150T-0022-FB
	17.50	0.6890	–		150T-17.5-SP	150A-17.5-SP	150N-17.5-SP	150T-17.5-FB

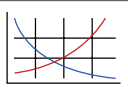
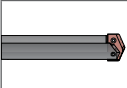
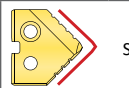
**NOTE:** 0.5 series inserts fit into both 0 and 0.5 series holders. However, 0 series inserts ONLY fit into 0 series holders. See page A30: 7 for visual.

A30: 114 - 145  A30: 38 - 42  A30: 4 - 6  SW A30: 4 - 6  FN

Coatings not listed above can be supplied as non-stocked standards. 

Inserts sold in quantities of 2

TiN = 131T-XXXX	TiAlN = 131A-XXXX
TiCN = 131N-XXXX	AM200® = 131H-XXXX

A DRILLING  
B BORING  
C REAMING  
D BURISHING  
E THREADING  
X SPECIALS