

SSD09

P M K N S H

S



κ_r	45°
a_{pmax}	4,5 mm

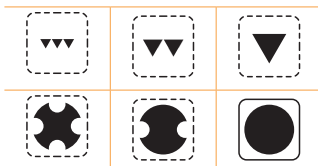
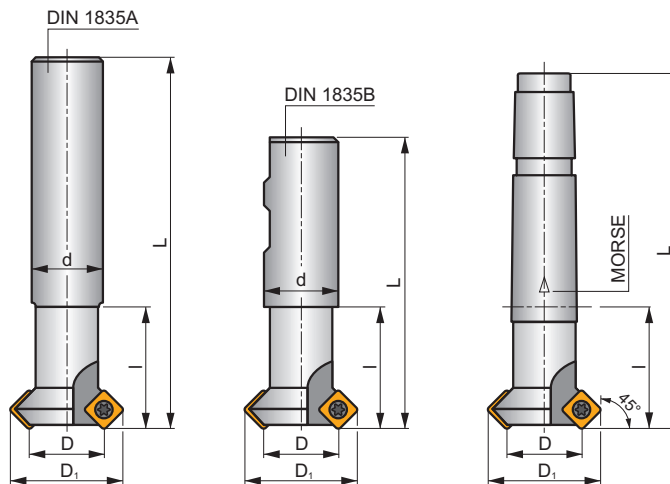
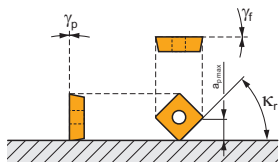

h_m 0,095 - 0,15



ISO	D	D ₁	L	d	l	Morse	γ_r°	γ_p°					kg		
16N2R027A16-SSD09	16	28	200	16	27	-	0	0	2	-	32200	-	0,37	GI129	CO070
25N3R042A25-SSD09	25	37	200	25	42	-	0	0	3	-	25800	-	0,78	GI129	CH011
10N1R027B16-SSD09-A	10	22	75	16	27	-	0	0	1	-	40700	-	0,14	GI129	CO070
16N2R027B16-SSD09-A	16	28	75	16	27	-	0	0	2	-	32200	-	0,14	GI129	CO070
25N3R042B25-SSD09-A	25	37	98	25	42	-	0	0	3	-	25800	-	0,37	GI129	CH011
10N1R030E02-SSD09-A	10	22	94	-	30	2	0	0	1	-	40700	-	0,17	GI129	CO070
16N2R030E02-SSD09-A	16	28	94	-	30	2	0	0	2	-	32200	-	0,25	GI129	CO070
25N3R043E03-SSD09-A	25	37	124	-	43	3	0	0	3	-	25800	-	0,38	GI129	CH011



GI129



SDEW 0903..



SDEX 0903..



CO070



US 3507-T15



3,0



M 3,5



7



Flag T15

CH011

US 3509-T15

3,0

M 3,5

9

Flag T15

SDEW 09

	d	d ₁	l	m	s
0903	9,525	4,40	9,525	1,64	3,18

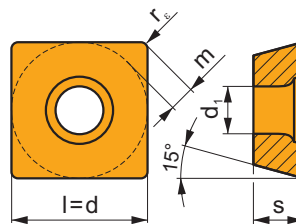

i	ISO	M	P	M	K	N	S	H	?	r _ε	f _{min}	f _{max}	a _{p min}	a _{p max}	
															U
U	SDEW 090308EN	M8330	█	□	█			█	☉	-	0,8	0,10	0,30	1,0	4,5
		M8340	█	□	█				☉	+/-	0,8	0,10	0,30	1,0	4,5
S	SDEW 090308SN	M8330	█	□	█			█	☉	-	0,8	0,15	0,30	1,0	4,5
		M8340	█	□	█				☒	+/-	0,8	0,15	0,30	1,0	4,5
		8215	█	□	█			█	☉	-	0,8	0,15	0,30	1,0	4,5

SDEX 09

	d	d ₁	l	m	s
0903	9,525	4,40	9,525	1,64	3,18

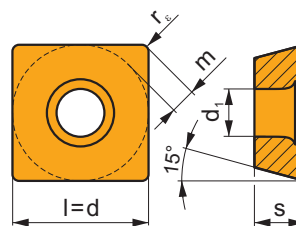

i	ISO	M	P	M	K	N	S	H	?	r _ε	f _{min}	f _{max}	a _{p min}	a _{p max}	
															F
F	SDEX 090308FN-74	M8330	█	█	█	□	□		☉	-	0,8	0,10	0,30	0,5	4,5

ISO	f_{min}	f_{max}	M8330	M8340	8215
P	●	-	281	268	293
	●	-	251	238	259
	✘	-	217	208	230
M	●	-	166	157	174
	●	-	149	140	157
	✘	-	132	123	136
K	●	-	268	255	276
	●	-	238	225	247
	✘	-	208	196	217
N	●	-	706	-	731
	●	-	629	-	655
	✘	-	548	-	578
S	●	-	81	77	85
	●	-	72	68	77
	✘	-	64	60	68
H	●	-	55	-	55
	●	-	47	-	51
	✘	-	43	-	43

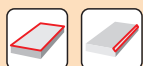

	SDEW 09 EN	SDEW 09 SN	SDEX 09
r_ϵ	0,8	0,8	0,8
a	-	-	-

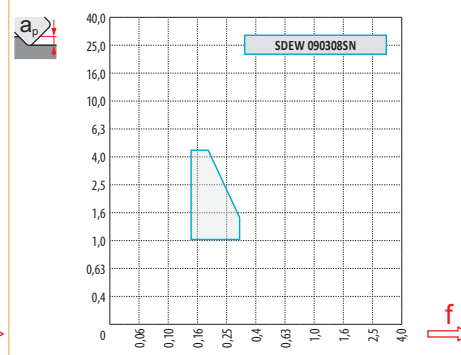
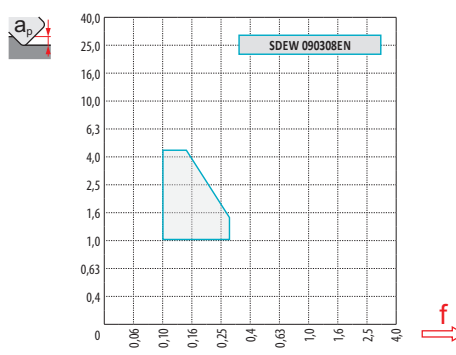

d_{min}	d_{max}	$X.V$	f_{min}	f_{max}
10	22	1,09	0,20	0,30
16	28	1,17	0,25	0,34
25	37	1,24	0,32	0,39



a_e/D	0,10	0,15	0,20	0,25	0,30	0,35	0,40	0,50 - 1,0																	
f	45	0,42	0,54	0,67	0,35	0,44	0,55	0,30	0,38	0,47	0,27	0,34	0,42	0,25	0,31	0,39	0,23	0,29	0,36	0,21	0,27	0,34	0,19	0,24	0,30
$X.V$	1,35	1,27	1,22	1,19	1,16	1,13	1,11	1,00																	