

SZD09

P

K

H

S

FEED ZD



a_{pmax} 1,0 mm

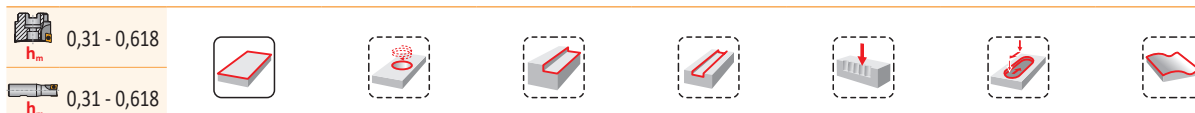
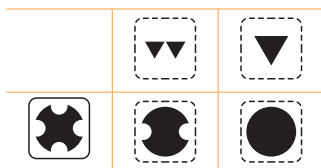
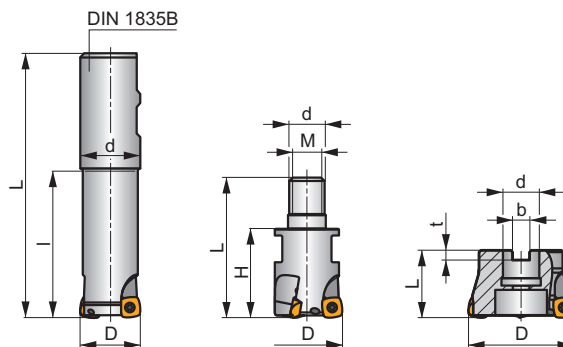
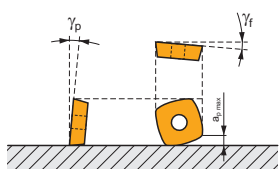

ISO	D	L	d	l	H	M	b	t	γ_f°	γ_p°					kg		
25E2R080B25-SZD09-C	25	140	25	80	-	-	-	-	-6	+10	2	-	22800	✓	0,49	GI191	SQ400
25E2R140B25-SZD09-C	25	200	25	140	-	-	-	-	-6	+10	2	-	22800	✓	0,60	GI191	SQ400
25E2R240B25-SZD09-C	25	300	25	240	-	-	-	-	-6	+10	2	-	22800	✓	0,90	GI191	SQ400
32E2R080B32-SZD09-C	32	140	32	80	-	-	-	-	-6	+10	2	-	20100	✓	0,80	GI191	SQ400
32E2R140B32-SZD09-C	32	200	32	140	-	-	-	-	-6	+10	2	-	20100	✓	1,07	GI191	SQ400
32E2R240B32-SZD09-C	32	300	32	240	-	-	-	-	-6	+10	2	-	20100	✓	1,57	GI191	SQ400
25E2R032M12-SZD09-C	25	54	12,5	-	32	M12	-	-	-6	+10	2	-	-	✓	0,15	GI191	SQ400
25E3R032M12-SZD09-C	25	54	12,5	-	32	M12	-	-	-6	+10	3	-	-	✓	0,14	GI191	SQ400
32E3R040M16-SZD09-C	32	63	17	-	40	M16	-	-	-6	+10	3	-	-	✓	0,26	GI191	SQ400
35E4R040M16-SZD09-C	35	63	17	-	40	M16	-	-	-6	+10	4	✓	-	✓	0,22	GI191	SQ400
42E4R040M16-SZD09-C	42	63	17	-	40	M16	-	-	-6	+10	4	✓	-	✓	0,27	GI191	SQ400
40A03R-SMOZD09-C	40	40	16	-	-	-	8,4	5,6	-6	+10	3	-	18000	✓	0,36	GI191	SQ402
40A04R-SMOZD09-C	40	40	16	-	-	-	8,4	5,6	-6	+10	4	✓	18000	✓	0,44	GI191	SQ402
50A05R-SMOZD09-C	50	40	22	-	-	-	10,4	6,4	-6	+10	5	✓	16000	✓	0,43	GI191	SQ403
52A05R-SMOZD09-C	52	40	22	-	-	-	10,4	6,4	-6	+10	5	✓	15700	✓	0,46	GI191	SQ403
63A06R-SMOZD09-C	63	40	22	-	-	-	10,4	6,4	-6	+10	6	✓	14300	✓	0,60	GI191	SQ403
66A06R-SMOZD09-C	66	50	27	-	-	-	12,0	7	-6	+10	6	✓	14000	✓	0,89	GI191	CO364

	GI191		ZDCW 09T3..
--	-------	--	-------------

SQ400	US 3006-T09P	2,0	M 3	6	-	-	Flag T09P	-
SQ402	US 3006-T09P	2,0	M 3	6	D-T07P/T09P	FG-15	-	HS 0830C
SQ403	US 3006-T09P	2,0	M 3	6	D-T07P/T09P	FG-15	-	HS 1030C
CO364	US 3006-T09P	2,0	M 3	6	D-T07P/T09P	FG-15	HS 1230C	-

ZDCW 09

	d	d ₁	l	s
09T3	9,525	3,40	9,53	3,97

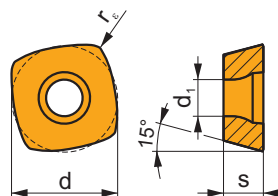

		ISO		P	M	K	N	S	H			r _c	f _{min}	f _{max}	a _{p min}	a _{p max}
		ZDCW 09T304	M8310	■		■			■		-	0,4	0,30	2,00	0,3	1,0
			M8325	■		□					-	0,4	0,30	2,00	0,3	1,0
			M8345	■							+ / -	0,4	0,30	2,00	0,3	1,0

ISO	f _{min}	f _{max}	M8310	M8325	M8345	
P		0,30	2,00	402	308	275
		0,30	1,80	363	275	242
		0,30	1,60	325	242	215
K		0,30	2,00	380	292	-
		0,30	1,80	347	259	-
		0,30	1,60	308	231	-
H		0,30	1,60	77	-	-
		0,30	1,40	72	-	-
		0,30	1,20	61	-	-

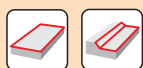

a_e/D	0,05	0,10	0,15	0,20	0,25	0,30	0,40	0,50	0,60	0,70	0,75	0,80	0,90	1,00
v	1,48	1,35	1,27	1,22	1,19	1,16	1,11	1,08	1,05	1,03	1,00	1,00	1,00	1,00
f	2,87	2,05	1,69	1,48	1,33	1,23	1,09	0,75	0,94	0,90	0,89	0,88	0,88	1,00
f	0,64	0,64	0,64	0,64	0,64	0,65	0,65	0,67	0,68	0,71	0,72	0,74	0,79	1,00

ZDCW 09	
r_ξ	0,4
a	-

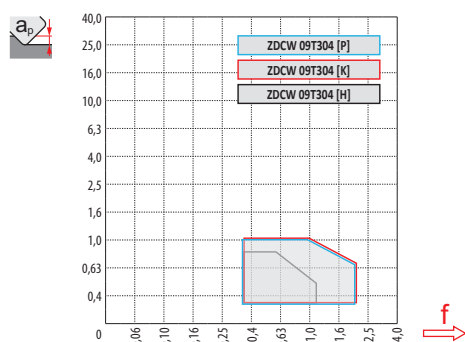

D	a_p	0,00	0,30	0,40	0,50	0,60	0,70	0,80	0,90	1,00
25	D	11,6	17,4	18,2	19,0	19,7	20,3	20,9	21,5	22,0
32	D	18,7	24,5	25,3	26,1	26,8	27,4	28,0	28,6	29,1
40	D	27,7	33,5	34,3	35,1	35,8	36,4	37,0	37,6	38,1

a_p	0,00	0,30	0,40	0,50	0,60	0,70	0,80	0,90	1,00
f	-	2,00	2,00	2,00	1,75	1,50	1,25	1,13	1,00

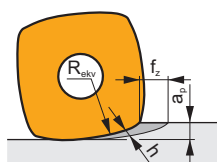

$$f_z = h_m \sqrt{\frac{2R_{ekv}}{a_{p\max}}}$$

[mm/zub]
 [мм/зуб]
 [mm/zub]
 [mm/zub]



Řiďte se údaji uvedenými pro frézování roviny. Snižte posuv na zub (f_z) na 50 % v blízkosti svislé plochy, aby se zabránilo vibracím a poškození břitu.

Данные рекомендации даны для случая фрезерования открытой плоскости. В случае обработки вблизи снижайте подачу на 50 % для предотвращения вибрации и поломки фрезы.

Postępuj zgodnie z instrukcjami podanymi dla płaszczyzn. W przypadku frezowania blisko powierzchni pionowej, należy zmniejszyć posuw na ząb (f_z) do 50 %, aby zapobiec drganiom i uszkodzeniom krawędzi skrawającej.

Postupujte podľa pokynov uvedených pre frézovanie rovinných plôch. V prípade frézovania zvislých plôch, znížte posuv na zub (f_z) na 50 %, aby sa zabránilo vibráciám a poškodeniu reznej hrany.



D	a_p	f_{max}
25	7,7	0,15
32	7,7	0,17
40	7,7	0,20



HFC



a_p	0,3	0,6	1,0
-------	-----	-----	-----



f	2,00	1,50	1,00
-----	------	------	------



HFC



25	12,0	1,0/6
32	7,5	1,0/11
40	3,6	1,0/17

25	0,9	1,00/65
32	0,5	0,75/100
40	0,4	0,55/100



d_{min}

d_{max}



25	35,0	50,0	0,45	1,00
32	49,0	64,0	0,45	0,85
40	65,0	80,0	0,50	0,85



25	0,15	0,15
32	0,15	0,17
40	0,15	0,20



μm

3

5

10

15

20

30

40

50

60

80

100

25	0,548	0,707	1,000	1,225	1,414	1,732	2,000	2,236	2,449	2,828	3,162
32	0,620	0,800	1,131	1,386	1,600	1,960	2,263	2,530	2,771	3,200	3,578
40	0,693	0,894	1,265	1,549	1,789	2,191	2,530	2,828	3,098	3,578	4,000

i

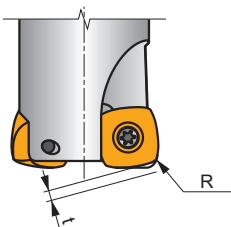

R

t

ZDCW 09T304

2,27

0,52