

VYMĚNITELNÉ BŘITOVÉ DESTIČKY  
VYMENITELNÉ REZNÉ DOŠTIČKY

- ISO C  
ISO C
- ISO D  
ISO D
- ISO M  
ISO M
- ISO P  
ISO P
- ISO S  
ISO S
- ZÁPÍCHY  
ZÁPÍCHY
- ZÁVITY  
ZÁVITY
- VBD  
VRD

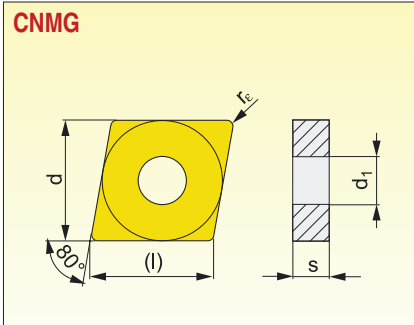

Velikost Velikost	l	d	d <sub>1</sub>	s
<b>0903</b>	9,7	9,525	3,81	3,18
<b>1204</b>	12,9	12,700	5,16	4,76
<b>1606</b>	16,1	15,875	6,35	6,35
<b>1906</b>	19,3	19,050	7,94	6,35

Nástroje viz str. / Nástroje vid' str.: 17, 23, 30-32, 49, 57, 76, 77







Utvářec Utvářec	ISO	ANSI	Materiály / Materiály								Rádus Rádus			Posuv na ot. Posuv na ot.		Hloubka řezu Hloubka řezu	
			6605	6615	6630	6640	9210	9230	9235	8016	8030	r <sub>c</sub>	f <sub>min</sub>	f <sub>max</sub>	a <sub>p min</sub>	a <sub>p max</sub>	
	CNMG 120404E-F	CNMG 431E-F	●	●	●			●	●	●	0,4	0,08	0,30	0,5	3,0		
	CNMG 120408E-F	CNMG 432E-F		●	●			●	●	●	0,8	0,08	0,35	0,8	3,0		
	CNMG 120404E-FF	CNMG 431E-FF							●		0,4	0,06	0,15	0,4	1,5		
	CNMG 120408E-FF	CNMG 432E-FF							●		0,8	0,08	0,20	0,8	1,5		
	CNMG 090304E-FM	CNMG 321E-FM					●	●		●	0,4	0,10	0,30	0,5	6,3		
	CNMG 090308E-FM	CNMG 322E-FM					●	●		●	0,8	0,10	0,45	0,8	3,0		
	CNMG 120404E-FM	CNMG 431E-FM					●	●		●	0,4	0,10	0,30	0,5	3,0		
	CNMG 120408E-FM	CNMG 432E-FM					●	●		●	0,8	0,15	0,45	0,8	3,0		
	CNMG 090308E-M	CNMG 322E-M					●	●	●		0,8	0,15	0,60	0,8	4,0		
	CNMG 120404E-M	CNMG 431E-M		●	●		●	●			0,4	0,17	0,60	0,8	6,0		
	CNMG 120408E-M	CNMG 432E-M	●	●	●	●	●	●	●		0,8	0,17	0,60	0,8	6,0		
	CNMG 120412E-M	CNMG 433E-M	●	●	●		●	●			1,2	0,17	0,60	1,2	6,0		
	CNMG 120416E-M	CNMG 434E-M	○	○			●	●			1,6	0,17	0,80	1,6	6,0		
	CNMG 160608E-M	CNMG 542E-M			●		●	●	●		0,8	0,17	0,60	0,8	7,0		
	CNMG 160612E-M	CNMG 543E-M			●		●	●	●		1,2	0,17	0,60	1,2	7,0		
	CNMG 160616E-M	CNMG 544E-M					●	●			1,6	0,17	0,60	1,6	7,0		
	CNMG 190608E-M	CNMG 642E-M			●	●	●	●	●		0,8	0,15	0,60	0,8	6,0		
	CNMG 190612E-M	CNMG 643E-M		○	●	●	●	●	●		1,2	0,17	0,80	1,2	8,0		
CNMG 190616E-M	CNMG 644E-M			●		●	●	●		1,6	0,17	0,80	1,6	8,0			
	CNMG 120408E-R	CNMG 432E-R	●	●	●	●	●	●			0,8	0,17	0,60	1,0	8,0		
	CNMG 120412E-R	CNMG 433E-R	●	●	●	○	●	●	○		1,2	0,25	0,70	2,0	6,0		
	CNMG 120416E-R	CNMG 434E-R	○	●		○	●	●			1,6	0,30	0,80	2,0	6,0		
	CNMG 160608E-R	CNMG 542E-R	○	●	○	○	●	●			0,8	0,25	0,60	3,0	7,0		
	CNMG 160612E-R	CNMG 543E-R	○	●	●	○	●	●			1,2	0,25	0,70	3,0	7,0		
	CNMG 160616E-R	CNMG 544E-R	○	●			●	●			1,6	0,25	0,70	3,0	7,0		
	CNMG 190608E-R	CNMG 642E-R	●	●	○	○	●	●			0,8	0,25	0,60	3,0	8,0		
	CNMG 190612E-R	CNMG 643E-R	●	●	●	●	●	●			1,2	0,25	0,70	3,0	8,0		
	CNMG 190616E-R	CNMG 644E-R	●	●	●	●	●	●			1,6	0,25	0,70	2,0	9,0		

● skladovaný ○ neskladovaný

Všechny rozměry v / Všetky rozmery v [mm]



VYMĚNITELNÉ BŘITOVÉ DESTIČKY  
VYMENITELNÉ REZNÉ DOŠTIČKY

Utvářec Utvárač	ISO	ANSI	Materiály / Materiály								Rádus Rádus	Posuv na ot. Posuv na ot.		Hloubka řezu Hloubka řezu		
			6605	6615	6630	6640	9210	9230	9235	8016		8030	$r_c$	$f_{min}$	$f_{max}$	$a_{p min}$
	<b>CNMG 120408E-DM</b>	CNMG 432E-DM		●				●				0,8	0,15	0,60	1,0	7,0
	<b>CNMG 160608E-DM</b>	CNMG 542E-DM						●				0,8	0,15	0,60	1,0	7,0
 	<b>CNMG 120408W-F</b>	CNMG 432W-F		●			●	●				0,8	0,10	0,60	0,2	4,4
	<b>CNMG 120408W-M</b>	CNMG 432W-M		●	●		●	●				0,8	0,15	0,60	0,8	4,0
	<b>CNMG 120412W-M</b>	CNMG 433W-M		●			●	●				1,2	0,20	0,90	1,2	4,0
	<b>CNMG 120404E-NM</b>	CNMG 431E-NM						●	●	●		0,4	0,15	0,30	0,5	3,0
	<b>CNMG 120408E-NM</b>	CNMG 432E-NM						●	●	●		0,8	0,20	0,40	0,8	3,0
	<b>CNMG 120412E-NM</b>	CNMG 433E-NM						●	●			1,2	0,20	0,40	1,2	3,5
	<b>CNMG 160608E-NM</b>	CNMG 542E-NM						●	●			0,8	0,25	0,50	0,8	5,0
	<b>CNMG 160612E-NM</b>	CNMG 543E-NM						●	●			1,2	0,25	0,50	1,2	5,0
	<b>CNMG 190612E-NM</b>	CNMG 643E-NM						●	●			1,2	0,30	0,50	1,2	8,0
 	<b>CNMG 120404ER-SI</b>	CNMG 431ER-SI		○				●		●		0,4	0,20	0,30	0,8	5,0
	<b>CNMG 120408ER-SI</b>	CNMG 432ER-SI		○				●		●		0,8	0,20	0,50	0,8	5,0
	<b>CNMG 120404EL-SI</b>	CNMG 431EL-SI		○				●		●		0,4	0,20	0,30	0,8	5,0
	<b>CNMG 120408EL-SI</b>	CNMG 432EL-SI		○				●		●		0,8	0,20	0,50	0,8	5,0

ISO C  
ISO C

ISO D  
ISO D

ISO M  
ISO M

ISO P  
ISO P

ISO S  
ISO S

ZÁPICHY  
ZÁPICHY

ZÁVITY  
ZÁVITY

VBD  
VRD

● skladovaný ○ neskladovaný

Všechny rozměry v / Všetky rozmery v [mm]