

HSK 63A

DIN 69871

JIS B 6339

DIN 2080

ADAPTÉRY  
ADAPTERS

PŘÍSLUŠENSTVÍ  
ACCESSORIES

TECHNICKÉ INFORMACE  
TECHNICAL INFORMATIONS

## 69871 AD-FMH2



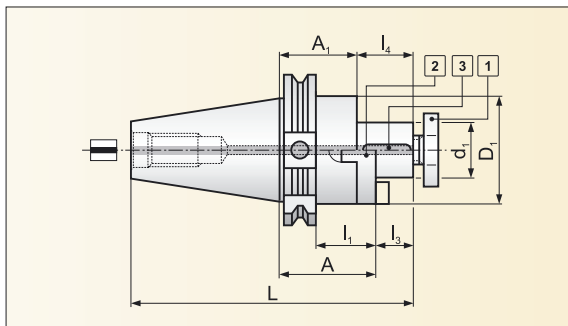































### UPÍNACÍ TRNY PRO NÁSTRČNÉ FRÉZY S VÝMĚNNÝM KROUŽKEM - TYP A+B COMBI SHELL MILL HOLDERS - A+B TYPE



POZNÁMKA: Maximální házivost průměru $d_1$ v porovnání s upínacím kuželem je 0,005 mm.	NOTE: Maximum run-out 0,005 mm.
---	------------------------------------

Označení PRAMET PRAMET specification	Sort. / Assort.	Rozměry / Dimensions											[kg]		
		Kužel Taper	$d_1$	A	$A_1$	$D_1$	L	$l_1$	$l_3$	$l_4$	-	-		-	
<b>69871.40AD-FMH2 2255</b>	o	40	22	55	43	40	142,4	36	19	31					1,25
<b>69871.40AD-FMH2 2755</b>	o	40	27	55	43	48	144,4	36	21	33					1,45
<b>69871.40AD-FMH2 3260</b>	o	40	32	60	46	58	152,4	41	24	38					1,75
<b>69871.40AD-FMH2 4060</b>	o	40	40	60	46	70	155,4	41	27	41					1,85
<b>69871.50AD-FMH2 1655</b>	o	50	16	55	45	32	173,7	36	17	27					2,95
<b>69871.50AD-FMH2 2255</b>	o	50	22	55	43	40	175,7	36	19	31					3,10
<b>69871.50AD-FMH2 2755</b>	o	50	27	55	43	48	177,7	36	21	33					3,30
<b>69871.50AD-FMH2 3255</b>	o	50	32	55	41	58	180,7	36	24	38					3,60
<b>69871.50AD-FMH2 4055</b>	o	50	40	55	41	70	183,7	36	27	41					4,05
<b>69871.50AD-FMH2 5070</b>	o	50	50	70	54	90	201,7	51	30	46					5,60
<b>69871.50A-FMH2 6060</b>	o	50	60	60	60	90	196,7	41	-	35					4,90

#### NÁHRADNÍ DÍLY - PŘÍSLUŠENSTVÍ / SPARE PARTS - ACCESSORIES

$d_1$	Náhradní díly / Spare parts			Příslušenství / Accessories		
	Šroub [1] Bolt [1]	Kroužek [2] Bague [2]	Pero [3] Flat key [3]	Klíč Key	Šroub Bolt	
16	 KS 1608	 R 16	 PR 16	 KK 16	 KSL 1608	
22	 KS 2210	 R 22	 PR 22	 KK 22	 KSL 2210	
27	 KS 2712	 R 27	 PR 27	 KK 27	 KSL 2712	
32	 KS 3216	 R 32	 PR 32	 KK 32	 KSL 3216	
40	 KS 4020	 R 40	 PR 40	 KK 40	 KSL 4020	
50	 KS 5024	 R 50	 PR 50	 KK 50	 KSL 5024	
60	 KS 6030	 -	 PR 60	 KK 60	 -	

● Skladovaný / Stock Assort. ○ Neskldovaný / Non-stock assort.

Všechny rozměry v [mm] / All dimensions [mm]