

Form AD

Form AD/B

Upínač Weldon / DIN 1835B

chladičí kapalina vedena středem

kombinovaný přívod chladičí kapaliny

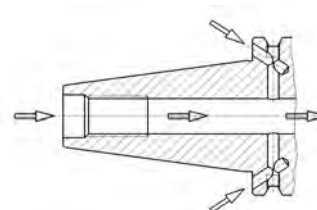
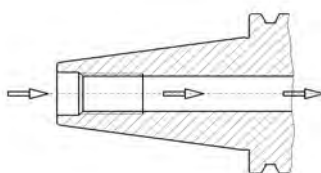

	SK	x	d	x	A	L	D	Artikel-Nr.	Artikel-Nr.
SK 30	30	x	6	x	50	98	25	G320 30x 6x 50	pouze AD
	30	x	8	x	50	98	28	G320 30x 8x 50	pouze AD
	30	x	10	x	50	98	35	G320 30x10x 50	pouze AD
	30	x	12	x	50	98	42	G320 30x12x 50	pouze AD
	30	x	14	x	50	98	42	G320 30x14x 50	pouze AD
	30	x	16	x	63	111	48	G320 30x16x 63	pouze AD
	30	x	18	x	63	111	48	G320 30x18x63	pouze AD
	30	x	20	x	63	111	52	G320 30x20x 63	pouze AD
SK 40	40	x	6	x	50	118	25	G320 40x 6x 50	G320D 40x 6x 50
	40	x	6	x	100	168	25	G320 40x 6x100	G320D 40x 6x100
6mm	40	x	6	x	160	228	25	pouze AD/B	G320D 40x 6x160
	40	x	6	x	200	268	25	pouze AD/B	G320D 40x 6x200
8mm	40	x	8	x	50	118	28	G320 40x 8x 50	G320D 40x 8x 50
	40	x	8	x	100	168	28	G320 40x 8x100	G320D 40x 8x100
	40	x	8	x	160	228	28	pouze AD/B	G320D 40x 8x160
	40	x	8	x	200	268	28	pouze AD/B	G320D 40x 8x200
	40	x	8	x	250	318	28	G320 40x 8x250	na poptávku
10mm	40	x	10	x	50	118	35	G320 40x10x 50	G320D 40x10x 50
	40	x	10	x	100	168	35	G320 40x10x100	G320D 40x10x100
	40	x	10	x	160	228	35	pouze AD/B	G320D 40x10x160
	40	x	10	x	200	268	35	pouze AD/B	G320D 40x10x200
	40	x	10	x	250	318	35	G320 40x10x250	na poptávku

Form AD

Form AD/B

Upínač Weldon / DIN 1835B

chladicí kapalina vedena středem

kombinovaný přívod chladicí kapaliny

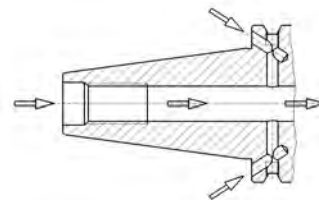
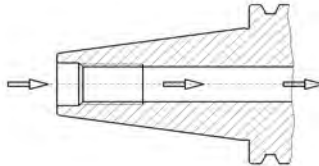

	SK	x	d	x	A	L	D	Artikel-Nr.	Artikel-Nr.
SK	40	x	12	x	50	118	42	G320 40x12x 50	G320D 40x12x 50
	40	x	12	x	100	168	42	G320 40x12x100	G320D 40x12x100
	40	x	12	x	160	228	42	pouze AD/B	G320D 40x12x160
12mm	40	x	12	x	200	268	42	pouze AD/B	G320D 40x12x200
	40	x	12	x	250	318	42	G320 40x12x250 na poptávku	pouze AD
14mm	40	x	14	x	50	118	42	G320 40x14x 50	G320D 40x14x 50
	40	x	14	x	100	168	42	pouze AD/B	G320D 40x14x100
	40	x	14	x	160	228	42	pouze AD/B	G320D 40x14x160 na poptávku
	40	x	14	x	200	268	42	pouze AD/B	G320D 40x14x200 na poptávku
16mm	40	x	16	x	35	103	48	G320 40x16x 35	pouze AD
	40	x	16	x	63	131	48	G320 40x16x 63	G320D 40x16x 63
	40	x	16	x	100	168	48	G320 40x16x100	G320D 40x16x100
	40	x	16	x	160	228	48	pouze AD/B	G320D 40x16x160
	40	x	16	x	200	268	48	pouze AD/B	G320D 40x16x200
	40	x	16	x	250	318	48	G320 40x16x250 na poptávku	pouze AD
18mm	40	x	18	x	63	131	48	G320 40x18x 63	G320D 40x18x 63
	40	x	18	x	100	168	48	pouze AD/B	G320D 40x18x100
	40	x	18	x	160	228	48	pouze AD/B	G320D 40x18x160 na poptávku
	40	x	18	x	200	268	48	pouze AD/B	G320D 40x18x200 na poptávku
20mm	40	x	20	x	35	103	44,45	G320 40x20x 35	G320D 40x20x 35
	40	x	20	x	63	131	52	G320 40x20x 63	G320D 40x20x 63
	40	x	20	x	100	168	52	G320 40x20x100	G320D 40x20x100
	40	x	20	x	160	228	52	pouze AD/B	G320D 40x20x160
	40	x	20	x	200	268	52	pouze AD/B	G320D 40x20x200
	40	x	20	x	250	318	52	G320 40x20x250 na poptávku	pouze AD
22mm	40	x	22	x	63	131	52	pouze AD/B	G320D 40x22x 63
25mm	40	x	25	x	35	103	44,45	G320 40x25x 35	G320D 40x25x 35
	40	x	25	x	100	168	63	G320 40x25x100	G320D 40x25x100
	40	x	25	x	160	228	63	pouze AD/B	G320D 40x25x160
	40	x	25	x	200	268	63	pouze AD/B	G320D 40x25x200
	40	x	25	x	250	318	63	G320 40x25x250 na poptávku	pouze AD
32mm	40	x	32	x	63	131	50	pouze AD/B	G320D 40x32x 63
	40	x	32	x	100	168	70	G320 40x32x100	G320D 40x32x100
	40	x	32	x	160	228	70	pouze AD/B	G320D 40x32x160
	40	x	32	x	200	268	70	pouze AD/B	G320D 40x32x200
40mm	40	x	40	x	120	188	80	G320 40x40x120	G320D 40x40x120

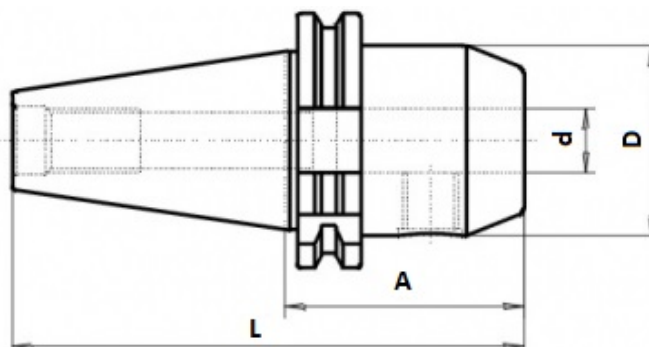

Form AD

Form AD/B

Upínač Weldon / DIN 1835B

chladicí kapalina vedena středem

kombinovaný přívod chladicí kapaliny

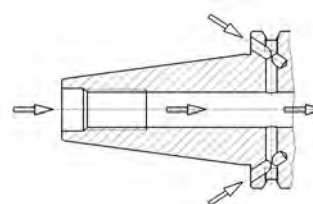
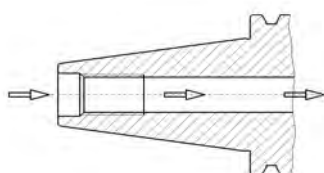

	SK	x	d	x	A	L	D	Artikel-Nr.	Artikel-Nr.
50 6mm	50	x	6	x	63	165	25	G320 50x 6x 63	G320D 50x 6x 63
	50	x	6	x	100	202	25	G320 50x 6x100	G320D 50x 6x100
	50	x	6	x	160	262	25	pouze AD/B	G320D 50x 6x160
8mm	50	x	8	x	63	165	28	G320 50x 8x 63	G320D 50x 8x 63
	50	x	8	x	100	202	28	G320 50x 8x100	G320D 50x 8x100
	50	x	8	x	160	262	28	pouze AD/B	G320D 50x 8x160
	50	x	8	x	200	302	28	pouze AD/B	G320D 50x 8x200
	50	x	8	x	250	352	28	G320 50x 8x250	na poptávku
10mm	50	x	10	x	63	165	35	G320 50x10x 63	G320D 50x10x 63
	50	x	10	x	100	202	35	G320 50x10x100	G320D 50x10x100
	50	x	10	x	160	262	35	pouze AD/B	G320D 50x10x160
	50	x	10	x	200	302	35	pouze AD/B	G320D 50x10x200
	50	x	10	x	250	352	35	G320 50x10x250	na poptávku
12mm	50	x	12	x	63	165	42	G320 50x12x 63	G320D 50x12x 63
	50	x	12	x	100	202	42	G320 50x12x100	G320D 50x12x100
	50	x	12	x	160	262	42	pouze AD/B	G320D 50x12x160
	50	x	12	x	200	302	42	pouze AD/B	G320D 50x12x200
	50	x	12	x	250	352	42	G320 50x12x250	na poptávku
14mm	50	x	14	x	63	165	42	G320 50x14x 63	G320D 50x14x 63
	50	x	14	x	100	202	42	pouze AD/B	G320D 50x14x100
16mm	50	x	16	x	63	165	48	G320 50x16x 63	G320D 50x16x 63
	50	x	16	x	100	202	48	G320 50x16x100	G320D 50x16x100
	50	x	16	x	160	262	48	pouze AD/B	G320D 50x16x160

vyvážený G6,3 - 15.000 U/min

Form AD

Form AD/B

Upínač Weldon / DIN 1835B

chladičí kapalina vedena středem kombinovaný přívod chladičí kapaliny

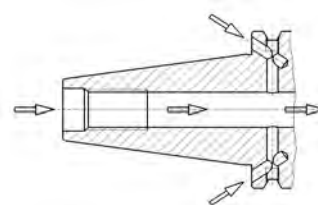
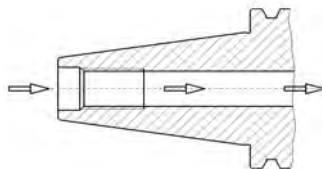

	SK	x	d	x	A	L	D	Artikel-Nr.	Artikel-Nr.
SK	50	x	18	x	63	165	48	G320 50x18x 63	G320D 50x18x 63
	50	x	18	x	100	202	48	pouze AD/B	G320D 50x18x100
	50	x	18	x	160	262	48	pouze AD/B	G320D 50x18x160
18mm	50	x	18	x	200	302	48	pouze AD/B	G320D 50x18x200 na poptávku
	50	x	20	x	35	137	70	pouze AD/B	G320D 50x20x 35
	50	x	20	x	63	165	52	G320 50x20x 63	G320D 50x20x 63
20mm	50	x	20	x	100	202	52	G320 50x20x100	G320D 50x20x100
	50	x	20	x	160	262	52	pouze AD/B	G320D 50x20x160
	50	x	20	x	200	302	52	pouze AD/B	G320D 50x20x200
	50	x	20	x	250	352	52	G320 50x20x250 na poptávku	pouze AD
	50	x	25	x	35	137	70	G320 50x25x 35 na poptávku	G320D 50x25x 35
25mm	50	x	25	x	80	182	63	G320 50x25x 80	G320D 50x25x 80
	50	x	25	x	160	262	63	pouze AD/B	G320D 50x25x160
	50	x	25	x	200	302	63	pouze AD/B	G320D 50x25x200
	50	x	25	x	250	352	63	G320 50x25x250 na poptávku	pouze AD
	50	x	32	x	35	137	80	pouze AD/B	G320D 50x32x 35
32mm	50	x	32	x	100	202	70	G320 50x32x100	G320D 50x32x100
	50	x	32	x	160	262	70	pouze AD/B	G320D 50x32x160
	50	x	32	x	200	302	70	pouze AD/B	G320D 50x32x200
40mm	50	x	40	x	100	202	80	G320 50x40x100	G320D 50x40x100
50mm	50	x	50	x	120	212	90	pouze AD/B	G320D 50x50x120

vyvážený G6,3 - 15.000 U/min

Příslušenství

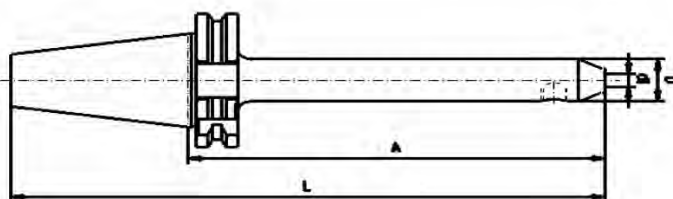
Náhradní šroub
G010BRedukce
G010Upínací čep
G050Průměry 25mm / 32mm /
40mm se 2 upínacími šrouby