

**Form AD**

**Form AD/B**

Upínač Weldon / DIN 1835B

chladičí kapalina vedena středem

kombinovaný přívod chladičí kapaliny

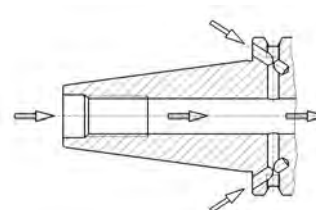
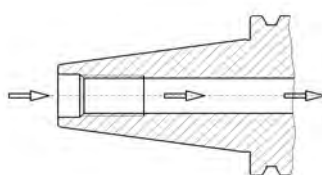

	SK	x	d	x	A	L	D	Artikel-Nr.	Artikel-Nr.
<b>SK 30</b>	30	x	6	x	50	98	25	G320 30x 6x 50	pouze AD
	30	x	8	x	50	98	28	G320 30x 8x 50	pouze AD
	30	x	10	x	50	98	35	G320 30x10x 50	pouze AD
	30	x	12	x	50	98	42	G320 30x12x 50	pouze AD
	30	x	14	x	50	98	42	G320 30x14x 50	pouze AD
	30	x	16	x	63	111	48	G320 30x16x 63	pouze AD
	30	x	18	x	63	111	48	G320 30x18x63	pouze AD
	30	x	20	x	63	111	52	G320 30x20x 63	pouze AD
<b>SK 40</b>	40	x	6	x	50	118	25	G320 40x 6x 50	G320D 40x 6x 50
	40	x	6	x	100	168	25	G320 40x 6x100	G320D 40x 6x100
<b>6mm</b>	40	x	6	x	160	228	25	pouze AD/B	G320D 40x 6x160
	40	x	6	x	200	268	25	pouze AD/B	G320D 40x 6x200
<b>8mm</b>	40	x	8	x	50	118	28	G320 40x 8x 50	G320D 40x 8x 50
	40	x	8	x	100	168	28	G320 40x 8x100	G320D 40x 8x100
	40	x	8	x	160	228	28	pouze AD/B	G320D 40x 8x160
	40	x	8	x	200	268	28	pouze AD/B	G320D 40x 8x200
	40	x	8	x	250	318	28	G320 40x 8x250 na poptávku	pouze AD
<b>10mm</b>	40	x	10	x	50	118	35	G320 40x10x 50	G320D 40x10x 50
	40	x	10	x	100	168	35	G320 40x10x100	G320D 40x10x100
	40	x	10	x	160	228	35	pouze AD/B	G320D 40x10x160
	40	x	10	x	200	268	35	pouze AD/B	G320D 40x10x200
	40	x	10	x	250	318	35	G320 40x10x250 na poptávku	pouze AD

## Form AD

## Form AD/B

Upínač Weldon / DIN 1835B

chladicí kapalina vedena středem

kombinovaný přívod chladicí kapaliny

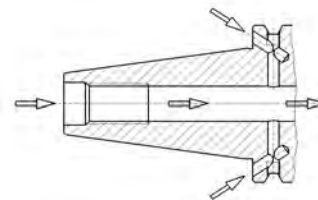
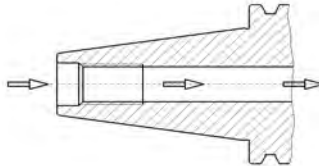

	SK	x	d	x	A	L	D	Artikel-Nr.	Artikel-Nr.
<b>SK</b>	<b>40</b>	x	12	x	50	118	42	G320 40x12x 50	G320D 40x12x 50
	<b>40</b>	x	12	x	100	168	42	G320 40x12x100	G320D 40x12x100
	<b>40</b>	x	12	x	160	228	42	pouze AD/B	G320D 40x12x160
<b>12mm</b>	<b>40</b>	x	12	x	200	268	42	pouze AD/B	G320D 40x12x200
	<b>40</b>	x	12	x	250	318	42	G320 40x12x250 na poptávku	pouze AD
<b>14mm</b>	<b>40</b>	x	14	x	50	118	42	G320 40x14x 50	G320D 40x14x 50
	<b>40</b>	x	14	x	100	168	42	pouze AD/B	G320D 40x14x100
	<b>40</b>	x	14	x	160	228	42	pouze AD/B	G320D 40x14x160 na poptávku
	<b>40</b>	x	14	x	200	268	42	pouze AD/B	G320D 40x14x200 na poptávku
<b>16mm</b>	<b>40</b>	x	16	x	35	103	48	G320 40x16x 35	pouze AD
	<b>40</b>	x	16	x	63	131	48	G320 40x16x 63	G320D 40x16x 63
	<b>40</b>	x	16	x	100	168	48	G320 40x16x100	G320D 40x16x100
	<b>40</b>	x	16	x	160	228	48	pouze AD/B	G320D 40x16x160
	<b>40</b>	x	16	x	200	268	48	pouze AD/B	G320D 40x16x200
	<b>40</b>	x	16	x	250	318	48	G320 40x16x250 na poptávku	pouze AD
<b>18mm</b>	<b>40</b>	x	18	x	63	131	48	G320 40x18x 63	G320D 40x18x 63
	<b>40</b>	x	18	x	100	168	48	pouze AD/B	G320D 40x18x100
	<b>40</b>	x	18	x	160	228	48	pouze AD/B	G320D 40x18x160 na poptávku
	<b>40</b>	x	18	x	200	268	48	pouze AD/B	G320D 40x18x200 na poptávku
<b>20mm</b>	<b>40</b>	x	20	x	35	103	44,45	G320 40x20x 35	G320D 40x20x 35
	<b>40</b>	x	20	x	63	131	52	G320 40x20x 63	G320D 40x20x 63
	<b>40</b>	x	20	x	100	168	52	G320 40x20x100	G320D 40x20x100
	<b>40</b>	x	20	x	160	228	52	pouze AD/B	G320D 40x20x160
	<b>40</b>	x	20	x	200	268	52	pouze AD/B	G320D 40x20x200
	<b>40</b>	x	20	x	250	318	52	G320 40x20x250 na poptávku	pouze AD
<b>22mm</b>	<b>40</b>	x	22	x	63	131	52	pouze AD/B	G320D 40x22x 63
<b>25mm</b>	<b>40</b>	x	25	x	35	103	44,45	G320 40x25x 35	G320D 40x25x 35
	<b>40</b>	x	25	x	100	168	63	G320 40x25x100	G320D 40x25x100
	<b>40</b>	x	25	x	160	228	63	pouze AD/B	G320D 40x25x160
	<b>40</b>	x	25	x	200	268	63	pouze AD/B	G320D 40x25x200
	<b>40</b>	x	25	x	250	318	63	G320 40x25x250 na poptávku	pouze AD
<b>32mm</b>	<b>40</b>	x	32	x	63	131	50	pouze AD/B	G320D 40x32x 63
	<b>40</b>	x	32	x	100	168	70	G320 40x32x100	G320D 40x32x100
	<b>40</b>	x	32	x	160	228	70	pouze AD/B	G320D 40x32x160
	<b>40</b>	x	32	x	200	268	70	pouze AD/B	G320D 40x32x200
<b>40mm</b>	<b>40</b>	x	40	x	120	188	80	G320 40x40x120	G320D 40x40x120

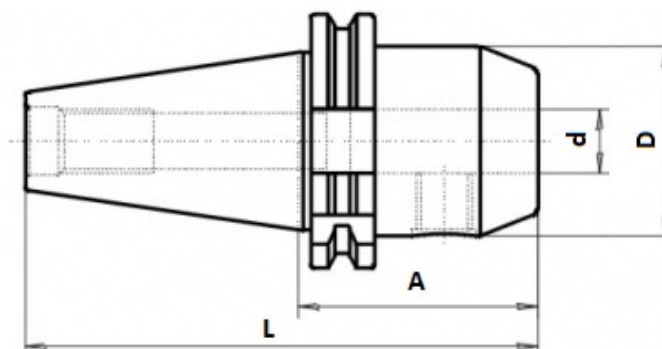

**Form AD**

**Form AD/B**

Upínač Weldon / DIN 1835B

chladičí kapalina vedena středem

kombinovaný přívod chladičí kapaliny

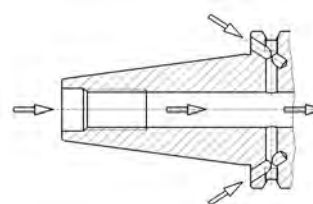
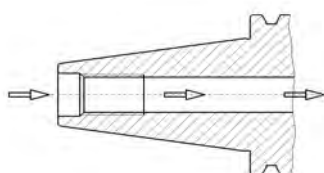

	SK	x	d	x	A	L	D	Artikel-Nr.	Artikel-Nr.
<b>50</b> 6mm	50	x	6	x	63	165	25	G320 50x 6x 63	G320D 50x 6x 63
	50	x	6	x	100	202	25	G320 50x 6x100	G320D 50x 6x100
	50	x	6	x	160	262	25	pouze AD/B	G320D 50x 6x160
<b>8mm</b>	50	x	8	x	63	165	28	G320 50x 8x 63	G320D 50x 8x 63
	50	x	8	x	100	202	28	G320 50x 8x100	G320D 50x 8x100
	50	x	8	x	160	262	28	pouze AD/B	G320D 50x 8x160
	50	x	8	x	200	302	28	pouze AD/B	G320D 50x 8x200
	50	x	8	x	250	352	28	G320 50x 8x250	na poptávku
<b>10mm</b>	50	x	10	x	63	165	35	G320 50x10x 63	G320D 50x10x 63
	50	x	10	x	100	202	35	G320 50x10x100	G320D 50x10x100
	50	x	10	x	160	262	35	pouze AD/B	G320D 50x10x160
	50	x	10	x	200	302	35	pouze AD/B	G320D 50x10x200
	50	x	10	x	250	352	35	G320 50x10x250	na poptávku
<b>12mm</b>	50	x	12	x	63	165	42	G320 50x12x 63	G320D 50x12x 63
	50	x	12	x	100	202	42	G320 50x12x100	G320D 50x12x100
	50	x	12	x	160	262	42	pouze AD/B	G320D 50x12x160
	50	x	12	x	200	302	42	pouze AD/B	G320D 50x12x200
	50	x	12	x	250	352	42	G320 50x12x250	na poptávku
<b>14mm</b>	50	x	14	x	63	165	42	G320 50x14x 63	G320D 50x14x 63
	50	x	14	x	100	202	42	pouze AD/B	G320D 50x14x100
<b>16mm</b>	50	x	16	x	63	165	48	G320 50x16x 63	G320D 50x16x 63
	50	x	16	x	100	202	48	G320 50x16x100	G320D 50x16x100
	50	x	16	x	160	262	48	pouze AD/B	G320D 50x16x160

vyvážený G6,3 - 15.000 U/min

## Form AD

## Form AD/B

Upínač Weldon / DIN 1835B

chladicí kapalina vedena středem kombinovaný přívod chladicí kapaliny

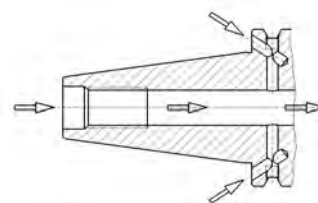
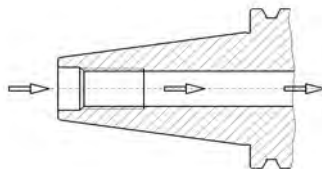

	SK	x	d	x	A	L	D	Artikel-Nr.	Artikel-Nr.
<b>SK 50</b>	50	x	18	x	63	165	48	G320 50x18x 63	G320D 50x18x 63
	50	x	18	x	100	202	48	pouze AD/B	G320D 50x18x100
	50	x	18	x	160	262	48	pouze AD/B	G320D 50x18x160
<b>18mm</b>	50	x	18	x	200	302	48	pouze AD/B	G320D 50x18x200 na poptávku
	50	x	20	x	35	137	70	pouze AD/B	G320D 50x20x 35
	50	x	20	x	63	165	52	G320 50x20x 63	G320D 50x20x 63
<b>20mm</b>	50	x	20	x	100	202	52	G320 50x20x100	G320D 50x20x100
	50	x	20	x	160	262	52	pouze AD/B	G320D 50x20x160
	50	x	20	x	200	302	52	pouze AD/B	G320D 50x20x200
	50	x	20	x	250	352	52	G320 50x20x250 na poptávku	pouze AD
	50	x	25	x	35	137	70	G320 50x25x 35 na poptávku	G320D 50x25x 35
<b>25mm</b>	50	x	25	x	80	182	63	G320 50x25x 80	G320D 50x25x 80
	50	x	25	x	160	262	63	pouze AD/B	G320D 50x25x160
	50	x	25	x	200	302	63	pouze AD/B	G320D 50x25x200
	50	x	25	x	250	352	63	G320 50x25x250 na poptávku	pouze AD
	50	x	32	x	35	137	80	pouze AD/B	G320D 50x32x 35
<b>32mm</b>	50	x	32	x	100	202	70	G320 50x32x100	G320D 50x32x100
	50	x	32	x	160	262	70	pouze AD/B	G320D 50x32x160
	50	x	32	x	200	302	70	pouze AD/B	G320D 50x32x200
<b>40mm</b>	50	x	40	x	100	202	80	G320 50x40x100	G320D 50x40x100
<b>50mm</b>	50	x	50	x	120	212	90	pouze AD/B	G320D 50x50x120

vyvážený G6,3 - 15.000 U/min

## Příslušenství

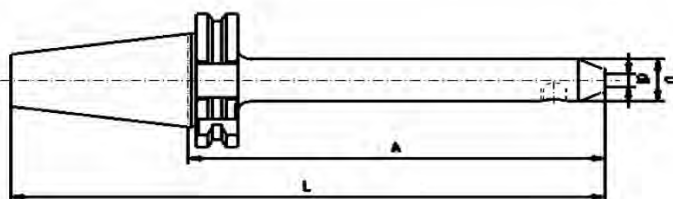
Náhradní šroub  
G010BRedukce  
G010Upínací čep  
G050Průměry 25mm / 32mm /  
40mm se 2 upínacími šrouby

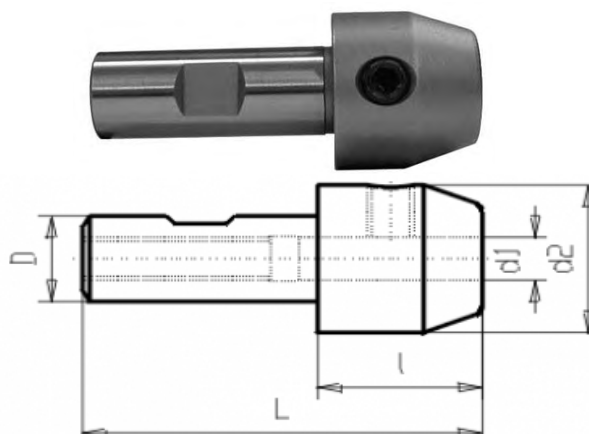
**Redukce Weldon**

Reducer for end mill holder

**Artikel-Nummer**

	D	x	d1	l	d2	L	
<b>G010</b>	20	x	6	25	25	75	
<b>G010</b>	20	x	8	27	28	77	
<b>G010</b>	20	x	10	30	35	80	
<b>G010</b>	20	x	12	35	42	85	
<b>G010</b>	32	x	6	30	25	90	
<b>G010</b>	32	x	8	30	28	90	
<b>G010</b>	32	x	10	35	35	95	
<b>G010</b>	32	x	12	35	42	95	
<b>G010</b>	32	x	14	35	42	95	
<b>G010</b>	32	x	16	40	48	100	
<b>G010</b>	32	x	18	40	48	100	
<b>G010</b>	32	x	20	40	52	100	na poptávku
<b>G010</b>	32	x	25	71	63	131	na poptávku

**Upínací šroub DIN1835B**

Clamping screw for Weldon

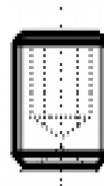
**Artikel-Nummer****Spann-Ø**

<b>G010B</b>	Ø 6mm	M6 x 10mm
<b>G010B</b>	Ø 8mm	M8 x 10mm
<b>G010B</b>	Ø 10mm	M10 x 12mm
<b>G010B</b>	Ø 12/14mm	M12 x 16mm
<b>G010B</b>	Ø 16/18mm	M14 x 16mm
<b>G010B</b>	Ø 20/22mm	M16 x 16mm
<b>G010B</b>	Ø 25mm	M18x2 20mm
<b>G010B</b>	Ø 32mm	M20x2 20mm
<b>G010B</b>	Ø 40mm	M20x2 20mm

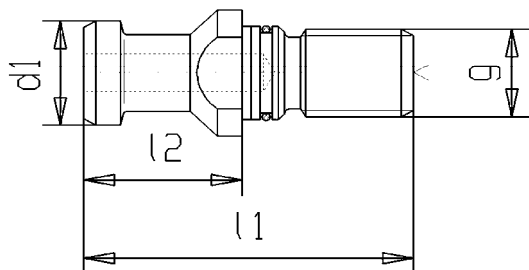

Tažný upínací čep DIN 69872 Standard

## Artikel-Nummer

	SK	Bohr.	d1	l2	l1	g
<b>G050</b>	<b>30</b>	mit	13	24	44	M12
<b>G050</b>	<b>40</b>	mit	19	26	54	M16
<b>G050</b>	<b>50</b>	mit	28	34	74	M24
<b>G050</b>	<b>30</b>	ohne	13	24	44	M12
<b>G050</b>	<b>40</b>	ohne	19	26	54	M16
<b>G050</b>	<b>50</b>	ohne	28	34	74	M24

mit = průchozí otvor

ohne = bez průchozího otvoru

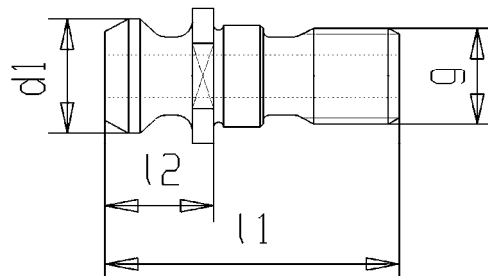

Tažný upínací čep ISO 7388 Typ B

## Artikel-Nummer

	SK	Bohr.	l1	l2	d1	g
<b>G051</b>	<b>40</b>	mit	45	16,3	19	M16
<b>G051</b>	<b>50</b>	mit	66	25,5	29	M24
<b>G051</b>	<b>40</b>	ohne	45	16,3	19	M16
<b>G051</b>	<b>50</b>	ohne	66	25,5	29	M24

Artikel-Nr.

\_\_\_\_\_

\_\_\_\_\_

Artikel-Nr.

\_\_\_\_\_

\_\_\_\_\_

Artikel-Nr.

\_\_\_\_\_

Artikel-Nr.

\_\_\_\_\_

Maximální přípustný utahovací moment: SK30 = 25 Nm  
 SK40 = 50 Nm  
 SK50 = 150 Nm