

Popis kazety
Opis kaset

Система обозначения картриджей
Kazety - popis

1	2	3	4
2CT	90	402 N	S

1	2	3		4
Тип nástroje Тип инструмента Typ narzędzia Typ nástroja	Úhel břitu Угол в плане Kąt przystawienia Vstupný uhol	Тип VBD Тип пластины Typ płytki Kód lôžka doštičky		Varianta Исполнение Wariant Varianta
2CT	30	300	TC..16T3.	S Stupňovité vyvrtávání Несимметричное расположение Niesymetryczne Stupňovité
3CT	45	402	CC..1204..	
	75	402N	CN..1204..	
	90			



Symetrické vyvrtávání / Симметричное расположение пластин
Wytaczanie symetryczne / Symetrické vyvrtávanie

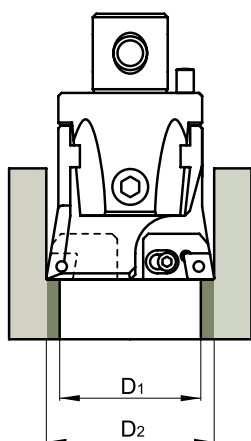

2CT □□ □□□ + 2CT □□ □□□
3CT □□ □□□ + 3CT □□ □□□

Stupňovité vyvrtávání / Несимметричное расположение пластин
Wytaczanie niesymetryczne / Stupňovité vyvrtávanie

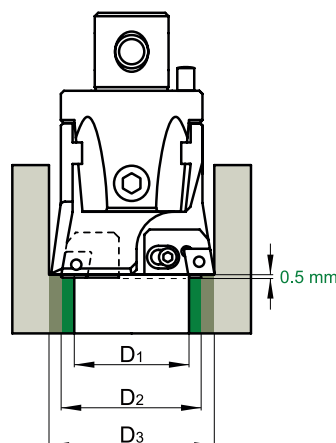

2CT □□ □□□ S + 2CT □□ □□□
3CT □□ □□□ S + 3CT □□ □□□

CART-BS



S(P)

Тип / Тип / Тур / Тур

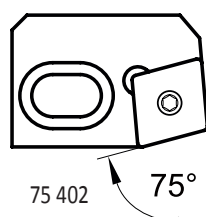
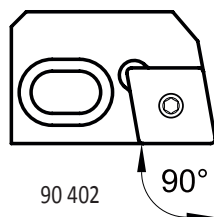
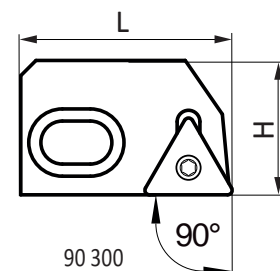
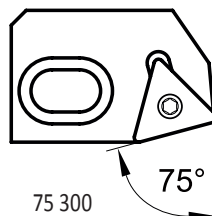
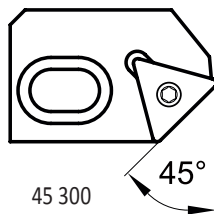
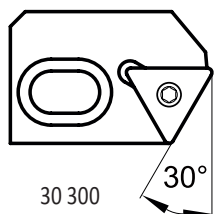

ISO	H	L									
2CT 30 300	22,5	35	US 0616	HXK 5	US 0430	HXK 2	TC.. 16T3..	US 0408-T15P	SDR T15P	0,05	
2CT 45 300	22,5	35	US 0616	HXK 5	US 0430	HXK 2	TC.. 16T3..	US 0408-T15P	SDR T15P	0,05	
2CT 75 300	22,5	35	US 0616	HXK 5	US 0430	HXK 2	TC.. 16T3..	US 0408-T15P	SDR T15P	0,05	
2CT 75 402	22,5	35	US 0616	HXK 5	US 0430	HXK 2	CC..1204..	US 0509-T20P	SDR T20P	0,05	
2CT 75 402 N	22,5	35	US 0616	HXK 5	US 0430	HXK 2	CN.. 1204..	US 0613-H25	HXK 2.5	0,05	
2CT 90 300	22,5	35	US 0616	HXK 5	US 0430	HXK 2	TC.. 16T3..	US 0408-T15P	SDR T15P	0,05	
2CT 90 402	22,5	35	US 0616	HXK 5	US 0430	HXK 2	CC..1204..	US 0509-T20P	SDR T20P	0,05	
2CT 90 402 N	22,5	35	US 0616	HXK 5	US 0430	HXK 2	CN.. 1204..	US 0613-H25	HXK 2.5	0,05	
2CT 90 300 S	23	33	US 0616	HXK 5	US 0430	HXK 2	TC.. 16T3..	US 0408-T15P	SDR T15P	0,05	
2CT 90 402 N S	23	33	US 0616	HXK 5	US 0430	HXK 2	CN.. 1204..	US 0613-H25	HXK 2.5	0,07	
2CT 90 402 S	23	33	US 0616	HXK 5	US 0430	HXK 2	CC..1204..	US 0509-T20P	SDR T20P	0,05	
3CT 30 300	28	39	US 0625	HXK 5	US 0635	HXK 3	TC.. 16T3..	US 0415-T15P	SDR T15P	0,10	
3CT 45 300	28	39	US 0625	HXK 5	US 0635	HXK 3	TC.. 16T3..	US 0415-T15P	SDR T15P	0,10	
3CT 75 300	28	39	US 0625	HXK 5	US 0635	HXK 3	TC.. 16T3..	US 0415-T15P	SDR T15P	0,10	
3CT 75 402	28	39	US 0625	HXK 5	US 0635	HXK 3	CC..1204..	US 0513-T20P	SDR T20P	0,10	
3CT 75 402 N	28	39	US 0625	HXK 5	US 0635	HXK 3	CN.. 1204..	US 0613-H25	HXK 2.5	0,10	
3CT 90 300	28	39	US 0625	HXK 5	US 0635	HXK 3	TC.. 16T3..	US 0415-T15P	SDR T15P	0,10	
3CT 90 402	28	39	US 0625	HXK 5	US 0635	HXK 3	CC..1204..	US 0513-T20P	SDR T20P	0,10	
3CT 90 402 N	28	39	US 0625	HXK 5	US 0635	HXK 3	CN.. 1204..	US 0613-H25	HXK 2.5	0,10	
3CT 90 300 S	28,5	37	US 0625	HXK 5	US 0635	HXK 3	TC.. 16T3..	US 0415-T15P	SDR T15P	0,10	
3CT 90 402 N S	28,5	37	US 0625	HXK 5	US 0635	HXK 3	CN.. 1204..	US 0613-H25	HXK 2.5	0,12	
3CT 90 402 S	28,5	37	US 0625	HXK 5	US 0635	HXK 3	CC..1204..	US 0513-T20P	SDR T20P	0,10	