

S90CN(XN)

P M K N S H

S



$\kappa_r$  90°  
 $a_{pmax}$  14,0 - 30,5 mm

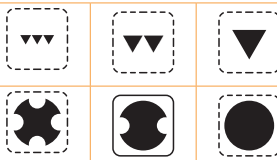
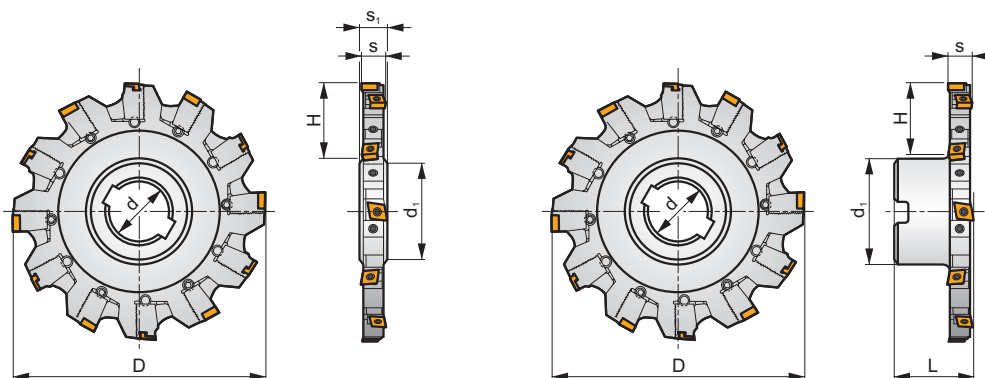
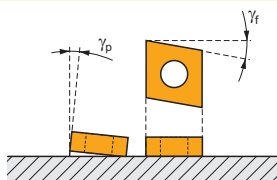

$h_m$  0,07 - 0,09  
 $h_m$  0,07 - 0,09



ISO	D	L	d	d <sub>1</sub>	H	s	s <sub>1</sub>	$\gamma_f^\circ$	$\gamma_p^\circ$	$\frac{x}{1}$					kg			
125H04N-S90CN10N18	125	-	40	56	34	14,0 ÷ 18,5	18	-10	+4	4	8	-	7800	-	1,50	GI195	DI051	-
160H06N-S90CN10N18	160	-	40	56	50	14,0 ÷ 18,5	18	-8	+4	6	12	-	6900	-	1,80	GI195	DI052	-
160H05N-S90CN12N24	160	-	40	56	50	19,0 ÷ 24,3	24	-8	+5	5	10	-	5200	-	2,50	GI196	DI056	-
200J07N-S90CN10N18	200	-	50	71	60	14,0 ÷ 18,5	18	-8	+4	7	14	-	6100	-	2,85	GI195	DI053	-
200J06N-S90CN12N24	200	-	50	71	60	19,0 ÷ 24,3	24	-8	+5	6	12	-	4700	-	3,60	GI196	DI057	-
200J06N-S90CN16N30	200	-	50	71	60	24,5 ÷ 30,5	30	-9	+5	6	12	-	4000	-	6,00	GI197	DI060	-
250J09N-S90CN10N18	250	-	50	71	85	14,0 ÷ 18,5	18	-8	+4	9	18	-	5500	-	5,30	GI195	DI054	-
250J08N-S90CN12N24	250	-	50	71	85	19,0 ÷ 24,3	24	-8	+5	8	16	-	4200	-	7,50	GI196	DI058	-
250J08N-S90CN16N30	250	-	50	71	85	24,5 ÷ 30,5	30	-8	+5	8	16	-	3600	-	8,00	GI197	DI061	-
315J12N-S90CN10N18	315	-	50	71	110	14,0 ÷ 18,5	18	-8	+4	12	24	-	4900	-	7,80	GI195	DI055	-
315J10N-S90CN12N24	315	-	50	71	110	19,0 ÷ 24,3	24	-8	+5	10	20	-	3700	-	11,00	GI196	DI059	-
315K10N-S90CN16N30	315	-	60	85	110	24,5 ÷ 30,5	30	-8	+5	10	20	-	3200	-	13,00	GI197	DI062	-
125B04R-S90CN10N18	125	50	40	70	25	14,0 ÷ 18,5	-	-10	+4	4	8	-	7800	-	1,65	GI195	DI071	AC003
160B06R-S90CN10N18	160	50	40	70	44	14,0 ÷ 18,5	-	-8	+5	6	12	-	6900	-	2,55	GI195	DI072	-
160B05R-S90CN12N24	160	50	40	70	44	19,0 ÷ 24,3	-	-8	+5	5	10	-	5200	-	2,90	GI196	DI074	-
200C06R-S90CN12N24	200	50	40	90	52	19,0 ÷ 24,3	-	-8	+5	6	12	-	6100	-	4,70	GI196	DI075	-
200C06R-S90CN16N30	200	50	60	130	34	24,5 ÷ 30,5	-	-9	+5	6	12	-	4700	-	5,95	GI197	DI076	-
200C07R-S90CN10N18	200	50	40	90	52	14,0 ÷ 18,5	-	-8	+4	7	14	-	6100	-	4,05	GI195	DI073	-



GI195	CNHQ 1005..
GI196	XNHQ 1205..
GI197	XNHQ 1606..

DI051	125H04N-S-14-08	KL-1418-CN10	KR-1418-CN10	KS 613F	DS 6018F	SDR T20	SS 6005-T09P	SDR T09	US 4011-T15P	3,5	M 4	11	SDR T15P	-
DI052	160H06N-S-14-12	KL-1418-CN10	KR-1418-CN10	KS 613F	DS 6018F	SDR T20	SS 6005-T09P	SDR T09	US 4011-T15P	3,5	M 4	11	SDR T15P	-
DI053	200J07N-S-14-14	KL-1418-CN10	KR-1418-CN10	KS 613F	DS 6018F	SDR T20	SS 6005-T09P	SDR T09	US 4011-T15P	3,5	M 4	11	SDR T15P	-
DI054	250J09N-S-14-18	KL-1418-CN10	KR-1418-CN10	KS 613F	DS 6018F	SDR T20	SS 6005-T09P	SDR T09	US 4011-T15P	3,5	M 4	11	SDR T15P	-
DI055	315J12N-S-14-24	KL-1418-CN10	KR-1418-CN10	KS 613F	DS 6018F	SDR T20	SS 6005-T09P	SDR T09	US 4011-T15P	3,5	M 4	11	SDR T15P	-
DI056	160H05N-S-19-10	KL-1924-XN12	KR-1924-XN12	KS 617M	DS 6500	-	SS 6005-T09P	SDR T09	US 4011-T15P	3,5	M 4	11	SDR T15P	HXK 4
DI057	200J06N-S-19-12	KL-1924-XN12	KR-1924-XN12	KS 617M	DS 6500	-	SS 6005-T09P	SDR T09	US 4011-T15P	3,5	M 4	11	SDR T15P	HXK 4
DI058	250J08N-S-19-16	KL-1924-XN12	KR-1924-XN12	KS 617M	DS 6500	-	SS 6005-T09P	SDR T09	US 4011-T15P	3,5	M 4	11	SDR T15P	HXK 4
DI059	315J10N-S-19-20	KL-1924-XN12	KR-1924-XN12	KS 617M	DS 6500	-	SS 6005-T09P	SDR T09	US 4011-T15P	3,5	M 4	11	SDR T15P	HXK 4
DI060	200J06N-S-25-12	KL-2530-XN16	KR-2530-XN16	KS 623M	DS 6500	-	SS 6005-T09P	SDR T09	US 4011-T15P	3,5	M 4	11	SDR T15P	HXK 4
DI061	250J08N-S-25-16	KL-2530-XN16	KR-2530-XN16	KS 623M	DS 6500	-	SS 6005-T09P	SDR T09	US 4011-T15P	3,5	M 4	11	SDR T15P	HXK 4
DI062	315K10N-S-25-20	KL-2530-XN16	KR-2530-XN16	KS 623M	DS 6500	-	SS 6005-T09P	SDR T09	US 4011-T15P	3,5	M 4	11	SDR T15P	HXK 4
DI071	125B04R-S-14-08	KL-1418-CN10	KR-1418-CN10	KS 613F	DS 6018F	SDR T20	SS 6005-T09P	SDR T09	US 4011-T15P	3,5	M 4	11	SDR T15P	-
DI072	160B06R-S-14-12	KL-1418-CN10	KR-1418-CN10	KS 613F	DS 6018F	SDR T20	SS 6005-T09P	SDR T09	US 4011-T15P	3,5	M 4	11	SDR T15P	-
DI073	200C07R-S-14-14	KL-1418-CN10	KR-1418-CN10	KS 613F	DS 6018F	SDR T20	SS 6005-T09P	SDR T09	US 4011-T15P	3,5	M 4	11	SDR T15P	-
DI074	160B05R-S-19-10	KL-1924-XN12	KR-1924-XN12	KS 617M	DS 6500	-	SS 6005-T09P	SDR T09	US 4011-T15P	3,5	M 4	11	SDR T15P	HXK 4
DI075	200C06R-S-19-12	KL-1924-XN12	KR-1924-XN12	KS 617M	DS 6500	-	SS 6005-T09P	SDR T09	US 4011-T15P	3,5	M 4	11	SDR T15P	HXK 4
DI076	200C06R-S-25-12	KL-2530-XN16	KR-2530-XN16	KS 623M	DS 6500	-	SS 6005-T09P	SDR T09	US 4011-T15P	3,5	M 4	11	SDR T15P	HXK 4

AC003	KS 2040	K.FMH40

## CNHQ

	b	d	d <sub>1</sub>	l	s
1005	0,5 × 45°	10,00	4,70	10,00	5,40

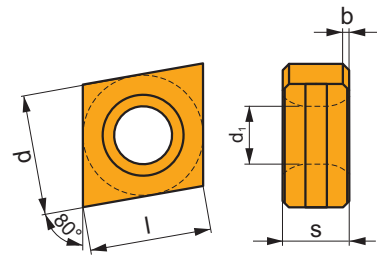

		ISO		P	M	K	N	S	H			r <sub>c</sub>	f <sub>min</sub>	f <sub>max</sub>	a <sub>p min</sub>	a <sub>p max</sub>
		CNHQ 1005AZTN	M8330	■	■	■	□	□	□	■	-	-	0,10	0,50	-	-
			M8340	■	■	■	□	□	□	■	+/-	-	0,10	0,50	-	-
			8230	■	■	■	□	□	□	■	-	-	0,10	0,50	-	-

# XNHQ

	b	d	d <sub>1</sub>	l	s
1205	0,5 × 45°	10,00	4,70	12,70	5,40
1606	0,5 × 45°	12,00	5,90	16,00	6,40

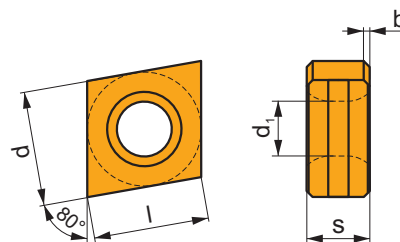

i		ISO		P	M	K	N	S	H	?		r <sub>c</sub>	f <sub>min</sub>	f <sub>max</sub>	a <sub>p min</sub>	a <sub>p max</sub>
U		XNHQ 1205AZTN	M8330	■	■	■	□	□	□	●	-	-	0,10	0,50	-	-
			M8340	■	■	■	□	□	□	●	+/-	-	0,10	0,50	-	-
T		XNHQ 1606AZTN	M8330	■	■	■	□	□	□	●	-	-	0,10	0,60	-	-
			M8340	■	■	■	□	□	□	●	+/-	-	0,10	0,60	-	-

ISO		f <sub>min</sub>	f <sub>max</sub>	M8330	M8340	8230
P	●	0,10	0,30	342	284	297
	●	0,10	0,25	306	252	266
	✘	0,10	0,15	265	221	230
M	●	0,10	0,25	194	167	176
	●	0,10	0,20	174	149	158
	✘	0,10	0,15	154	131	140
K	●	0,10	0,30	327	270	284
	●	0,10	0,25	290	239	252
	✘	0,10	0,15	254	207	221
N	●	0,10	0,30	859	-	747
	●	0,10	0,25	766	-	666
	✘	0,10	0,15	668	-	581
S	●	0,10	0,25	95	81	86
	●	0,10	0,20	85	72	77
	✘	0,10	0,15	75	63	68
H	●	0,10	0,20	68	-	59
	●	0,10	0,15	58	-	50
	✘	0,10	0,12	52	-	45

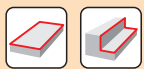

$\frac{a_p}{D}$	0,05	0,10	0,15	0,20	0,25	0,30	0,40	0,50	0,60	0,70	0,75	0,80	0,90	1,00
$\chi.v$	1,48	1,35	1,27	1,22	1,19	1,16	1,11	1,08	1,05	1,03	1,00	1,00	1,00	1,00

	CNHQ 10	XNHQ 12	XNHQ 16
$r_f$	-	-	-
$a$	-	-	-

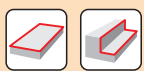
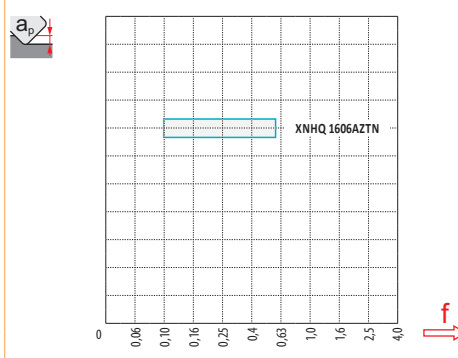
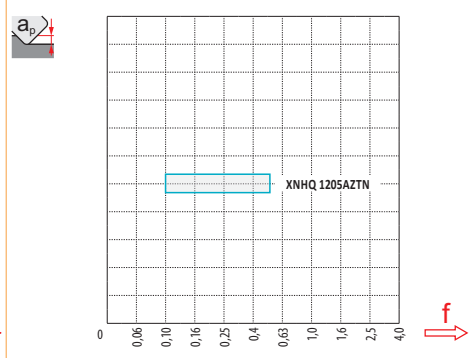
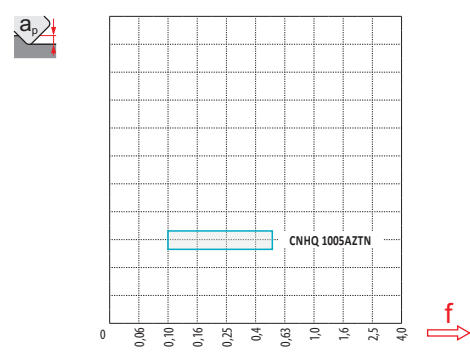

	125	4	34	34
	160	6	50	50
	200	7	60	60
	250	9	85	85
	315	12	110	110
	125	4	25	125
	160	6	44	160
	200	7	52	200

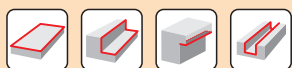

$a_e$	5		10		15		20		25		
	$f_{min}$	$f_{max}$	$f_{min}$	$f_{max}$	$f_{min}$	$f_{max}$	$f_{min}$	$f_{max}$	$f_{min}$	$f_{max}$	
	125	0,35	0,45	0,25	0,32	0,21	0,27	0,18	0,23	0,16	0,21
	160	0,40	0,51	0,28	0,36	0,23	0,30	0,20	0,26	0,18	0,23
	200	0,44	0,57	0,32	0,41	0,26	0,33	0,23	0,29	0,20	0,26
	250	0,50	0,64	0,35	0,45	0,29	0,37	0,25	0,32	0,23	0,29
	315	0,56	0,72	0,39	0,51	0,32	0,42	0,28	0,36	0,25	0,32
	125	0,35	0,45	0,25	0,32	0,21	0,27	0,18	0,23	0,16	0,21
	160	0,40	0,51	0,28	0,36	0,23	0,30	0,20	0,26	0,18	0,23
	200	0,44	0,57	0,32	0,41	0,26	0,33	0,23	0,29	0,20	0,26
$a_e$	32		40		50		63		80		
	$f_{min}$	$f_{max}$	$f_{min}$	$f_{max}$	$f_{min}$	$f_{max}$	$f_{min}$	$f_{max}$	$f_{min}$	$f_{max}$	
	125	0,15	0,19	-	-	-	-	-	-	-	-
	160	0,16	0,21	0,15	0,19	-	-	-	-	-	-
	200	0,18	0,23	0,16	0,21	0,15	0,19	-	-	-	-
	250	0,20	0,26	0,18	0,23	0,16	0,21	0,15	0,19	0,13	0,17
	315	0,22	0,29	0,20	0,26	0,18	0,23	0,16	0,21	0,15	0,19
	125	0,15	0,19	0,13	0,17	0,12	0,15	0,11	0,14	0,10	0,13
	160	0,16	0,21	0,15	0,19	0,13	0,17	0,12	0,16	0,11	0,14
	200	0,18	0,23	0,16	0,21	0,15	0,19	0,13	0,17	0,12	0,15
$a_e$	100		125		160		200				
	$f_{min}$	$f_{max}$	$f_{min}$	$f_{max}$	$f_{min}$	$f_{max}$	$f_{min}$	$f_{max}$			
	125	-	-	-	-	-	-	-			
	160	-	-	-	-	-	-	-			
	200	-	-	-	-	-	-	-			
	250	-	-	-	-	-	-	-			
	315	0,13	0,17	-	-	-	-	-			
	125	0,10	0,12	0,10	0,11	-	-	-			
	160	0,10	0,13	0,10	0,12	0,10	0,11	-			
	200	0,11	0,14	0,10	0,13	0,10	0,12	0,10	0,11		